

# Easter Pack

Easter learning fun for grades PreK – 2<sup>nd</sup>!

## Perform a Puppet Show



**Directions:** Cut out the puppets of Jesus, the Disciple. Glue the puppets onto something rigid like straws and use with your puppet show. Then, act out and read John:20 to tell the story of Mary Magdalene and Jesus.

Made for <http://www.freehomeschooldeals.com/> by: <http://enchantedschoolingmom.net>

**Directions:** Cut out the image below into strips on the dotted lines. Then have your child practice number order by completing the picture.

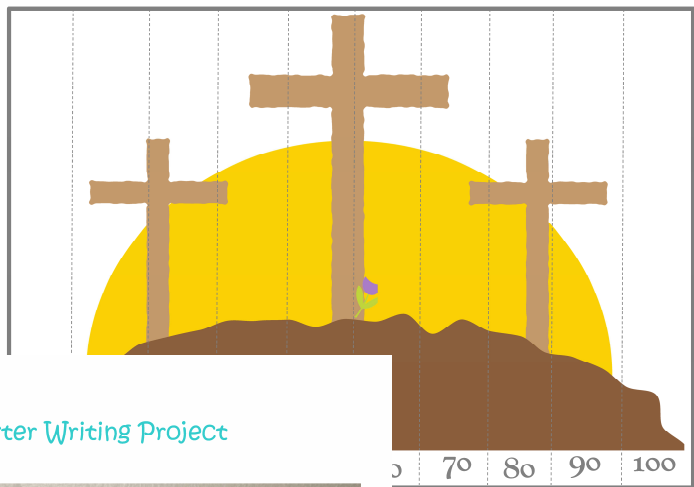

## Easter Writing Project



**Directions:** Complete the writing prompt page on the following page. Then cut, and fold, then paste the image of Jesus on to the top of the writing prompt page. Glue the writing prompt page onto a piece of spring colored construction paper. Then proudly hang it on your wall to help celebrate Easter!

Made for <http://www.freehomeschooldeals.com/> by: <http://enchantedschoolingmom.net>

Clip Art By:

**Directions:** Cut out all of the letter pairs on the outer edges and along the dotted line. Mix-up all the cards and have your child match up the lower and upper case pieces of each letter pair.

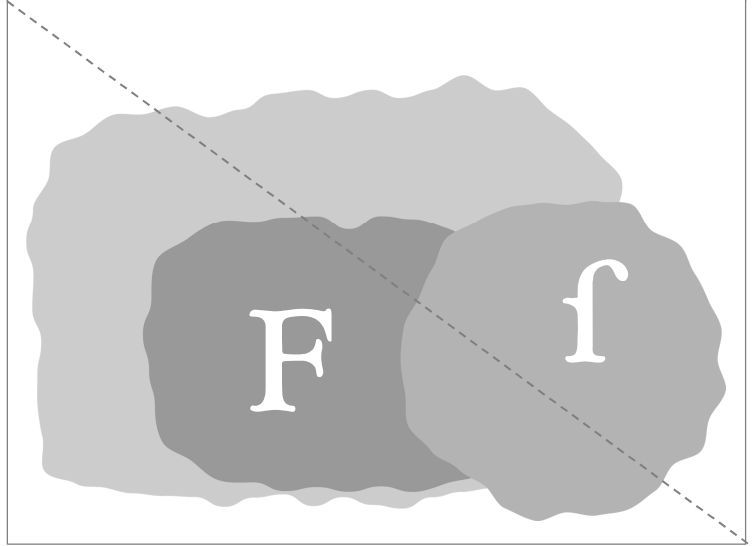
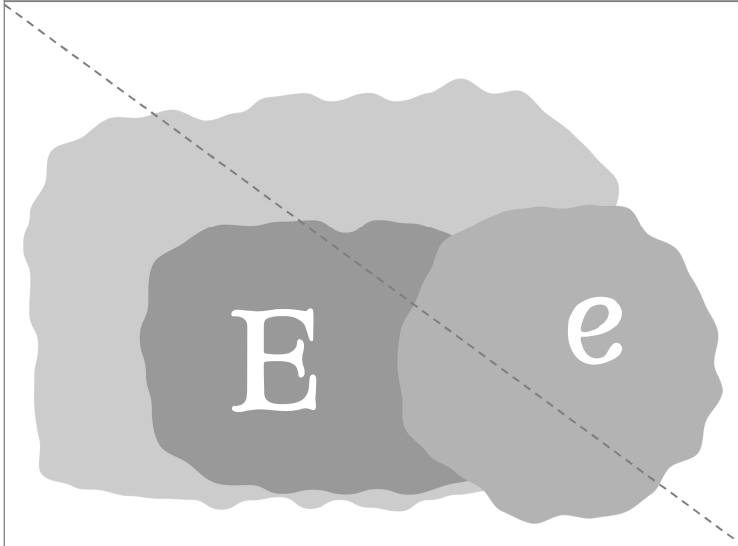
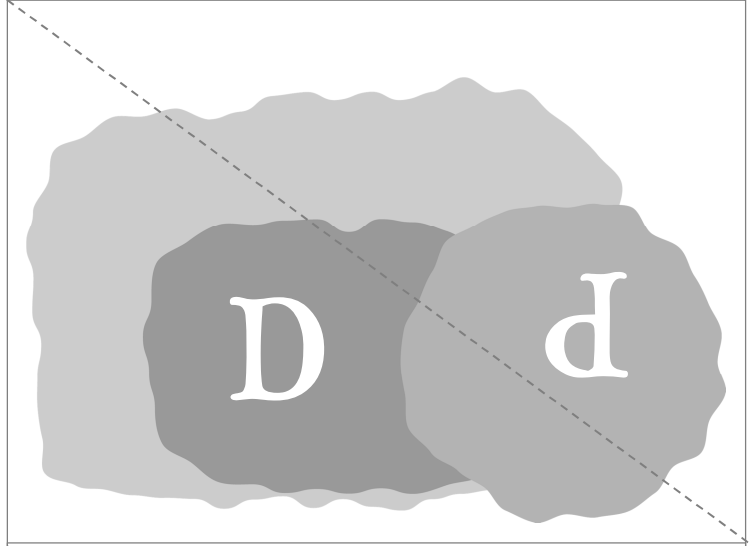
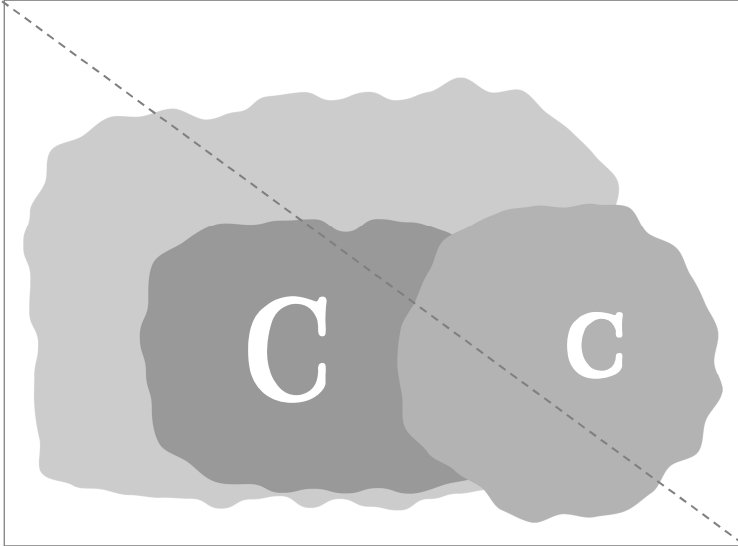
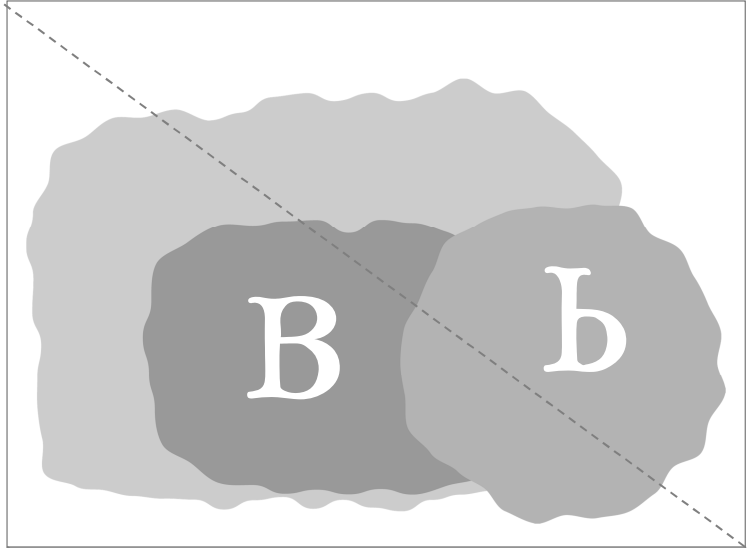
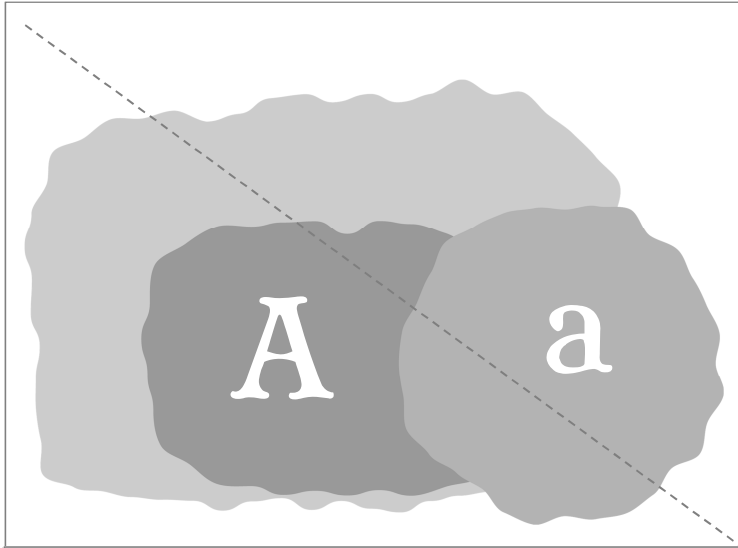

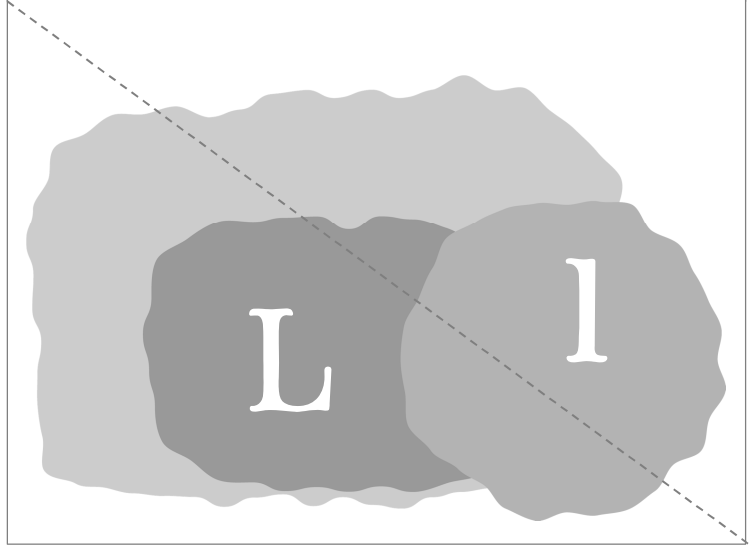
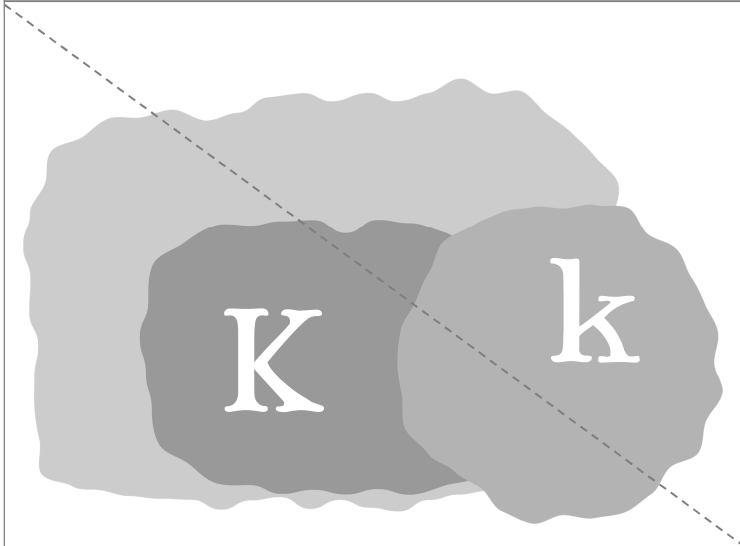
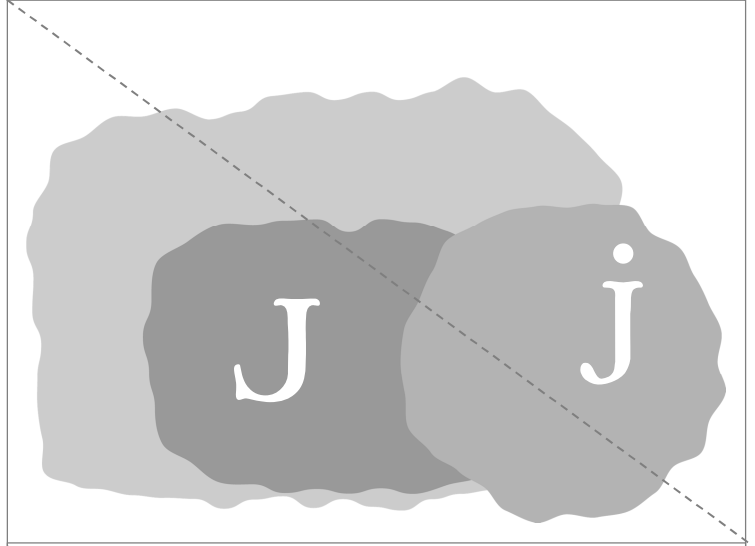
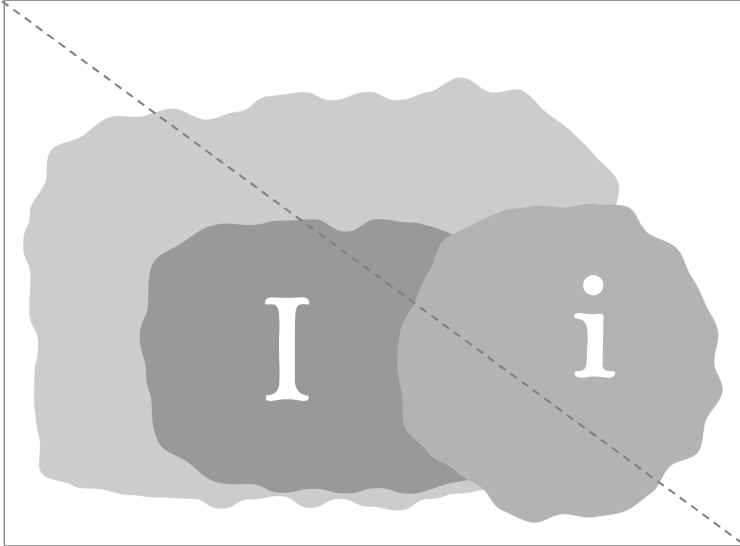
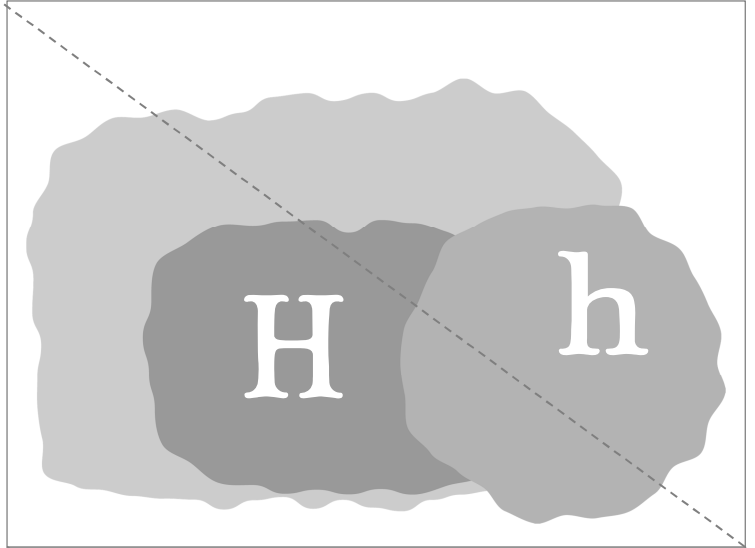
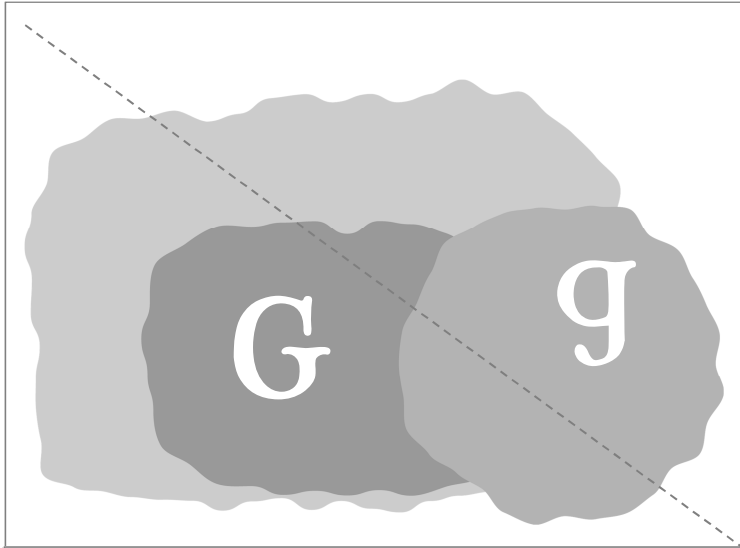

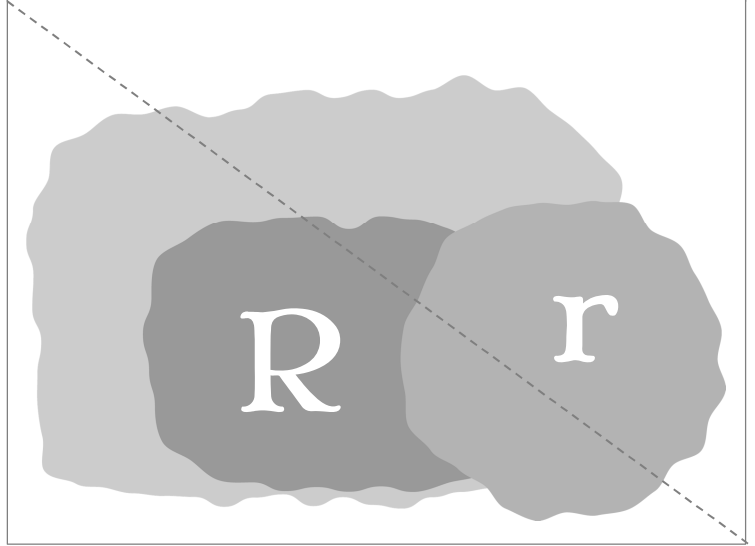
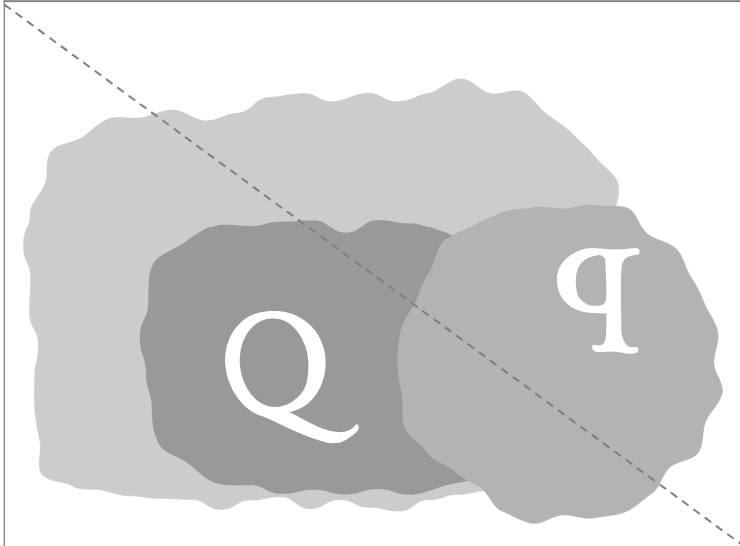
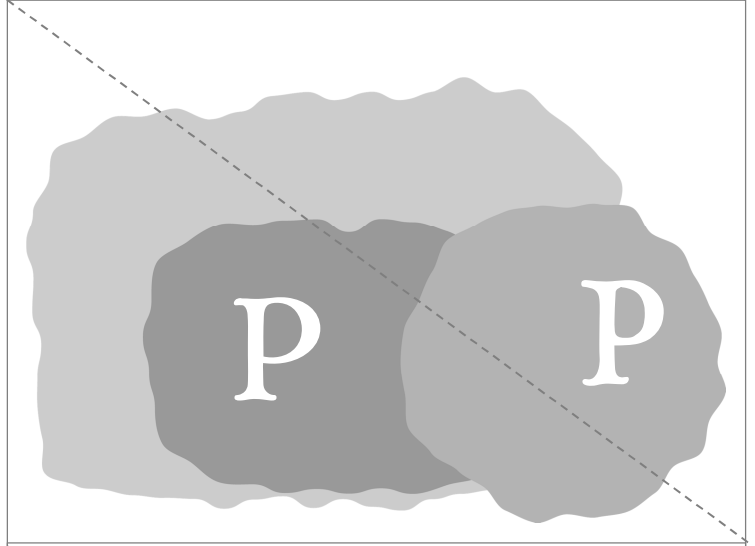
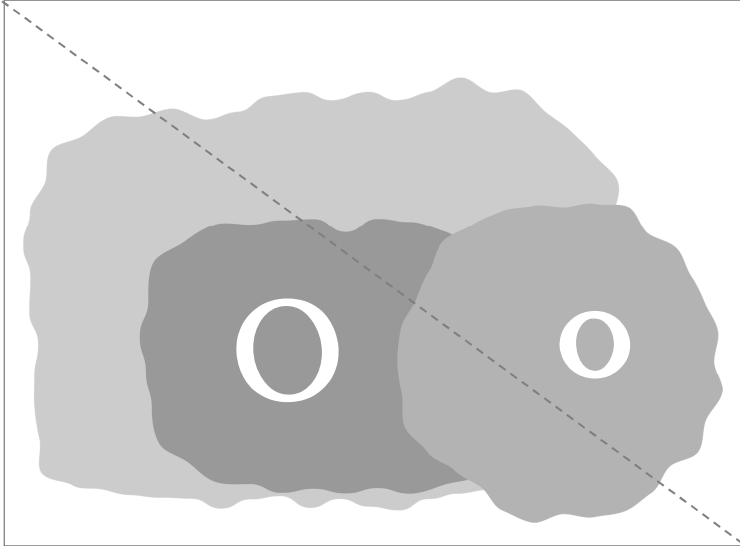
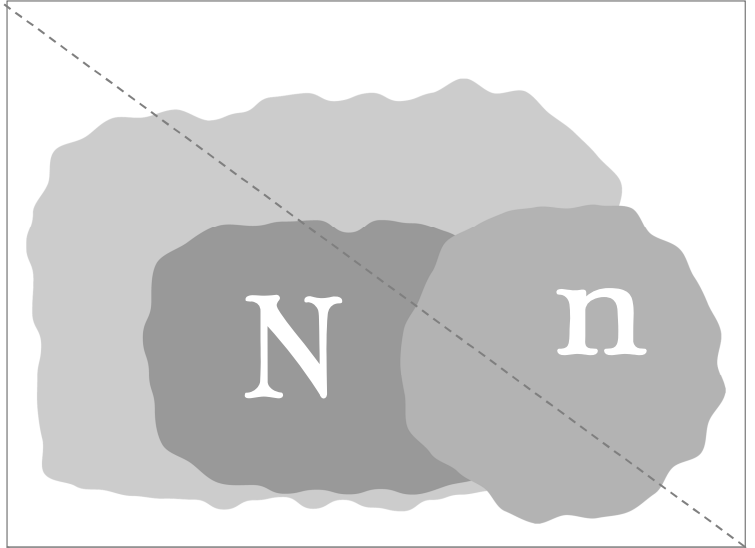
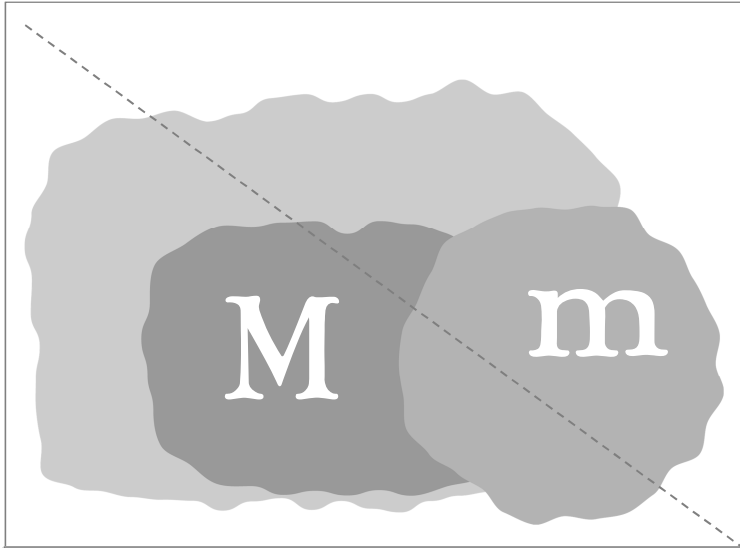



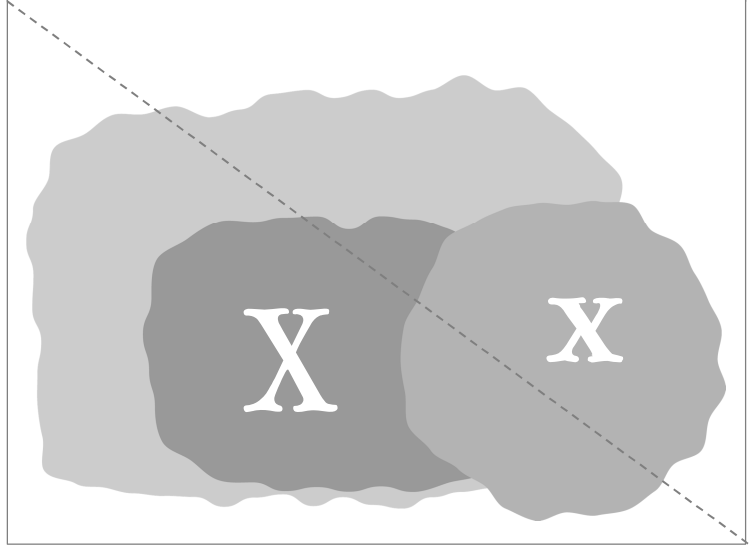
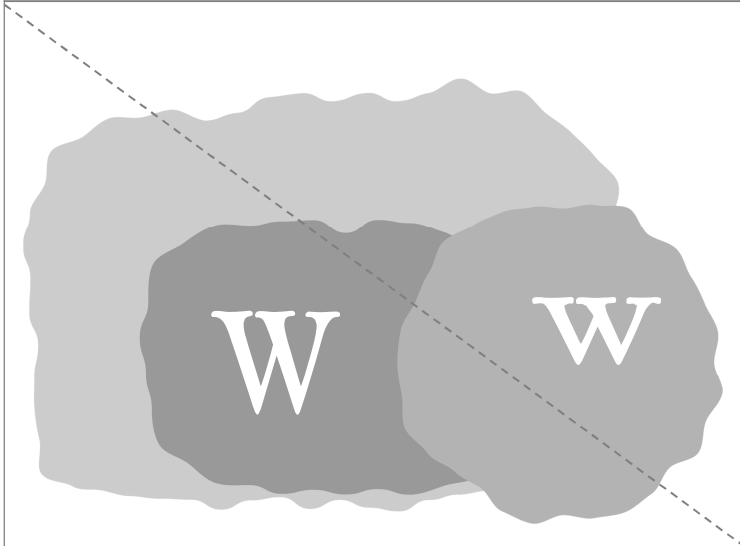
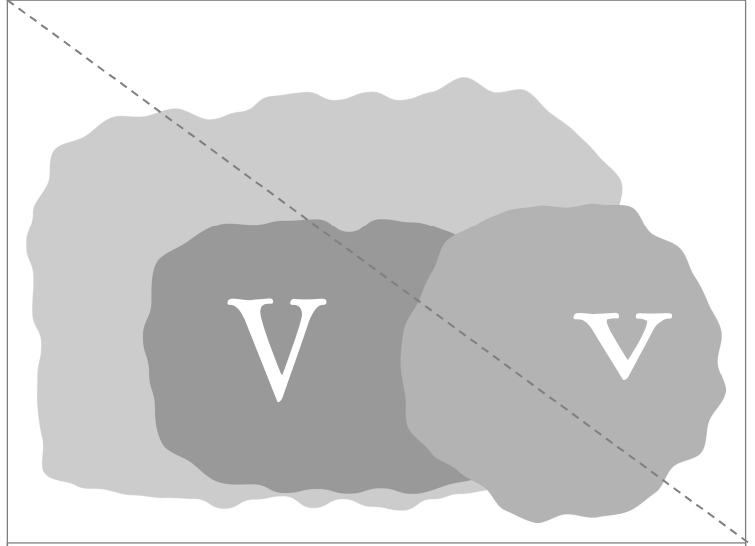
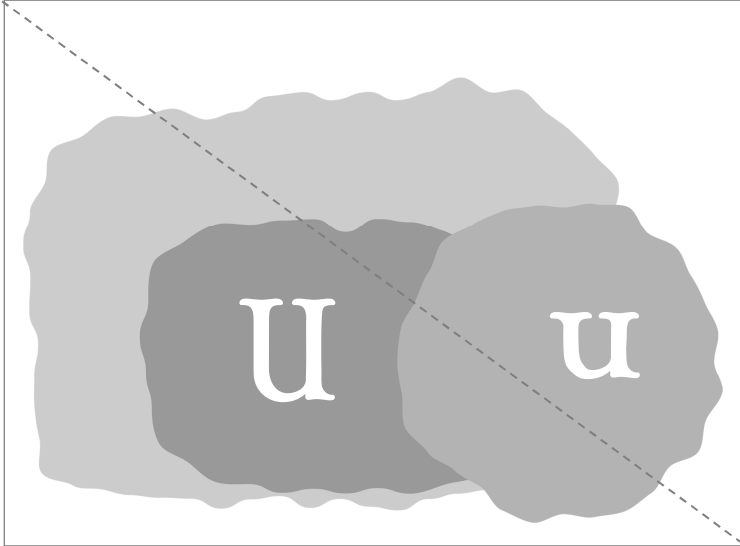
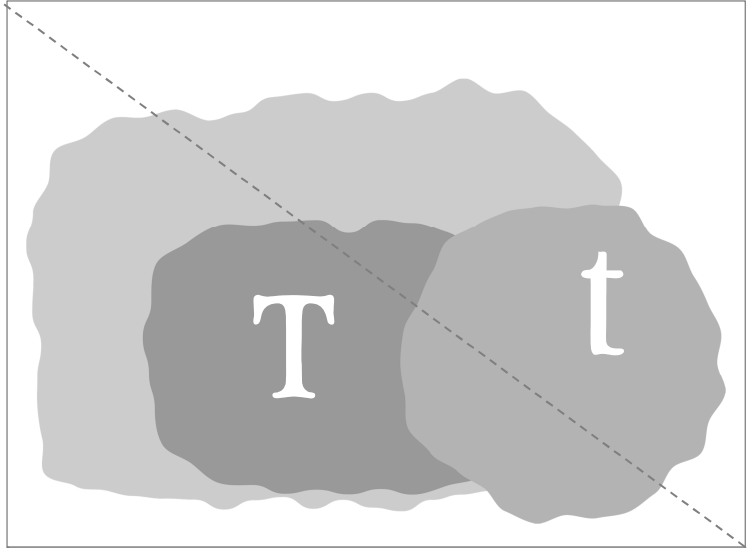
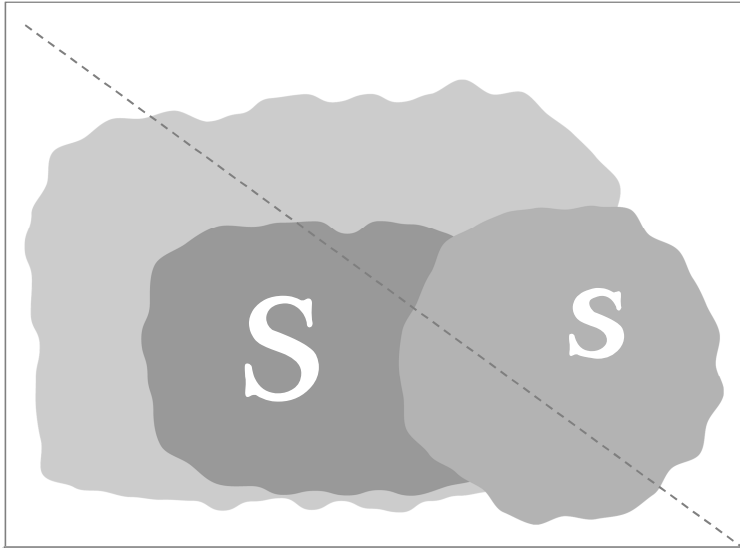

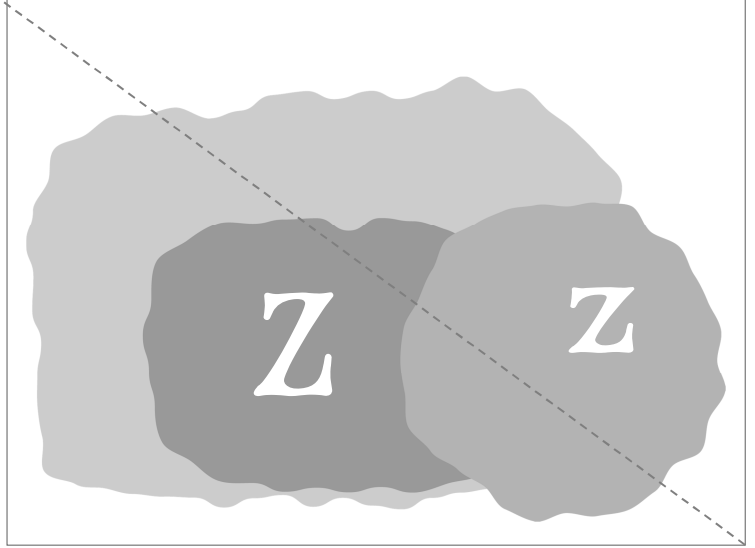
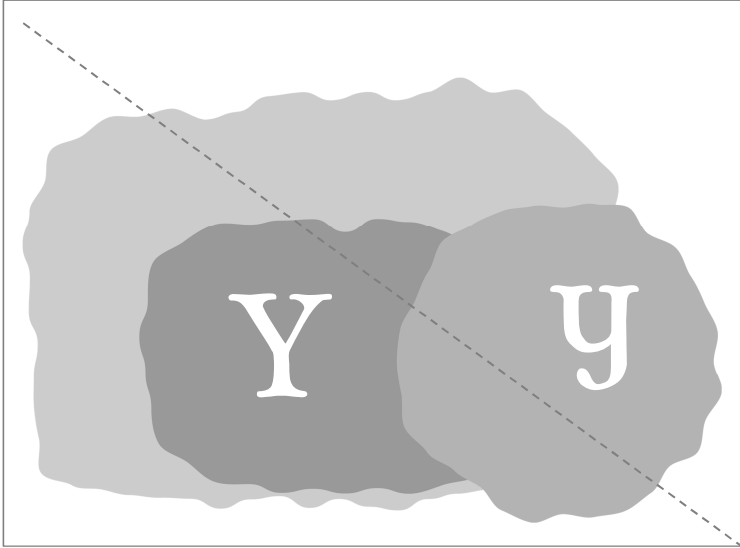

**Directions:** Cover the dots on this page using Do-A-Dot Markers.

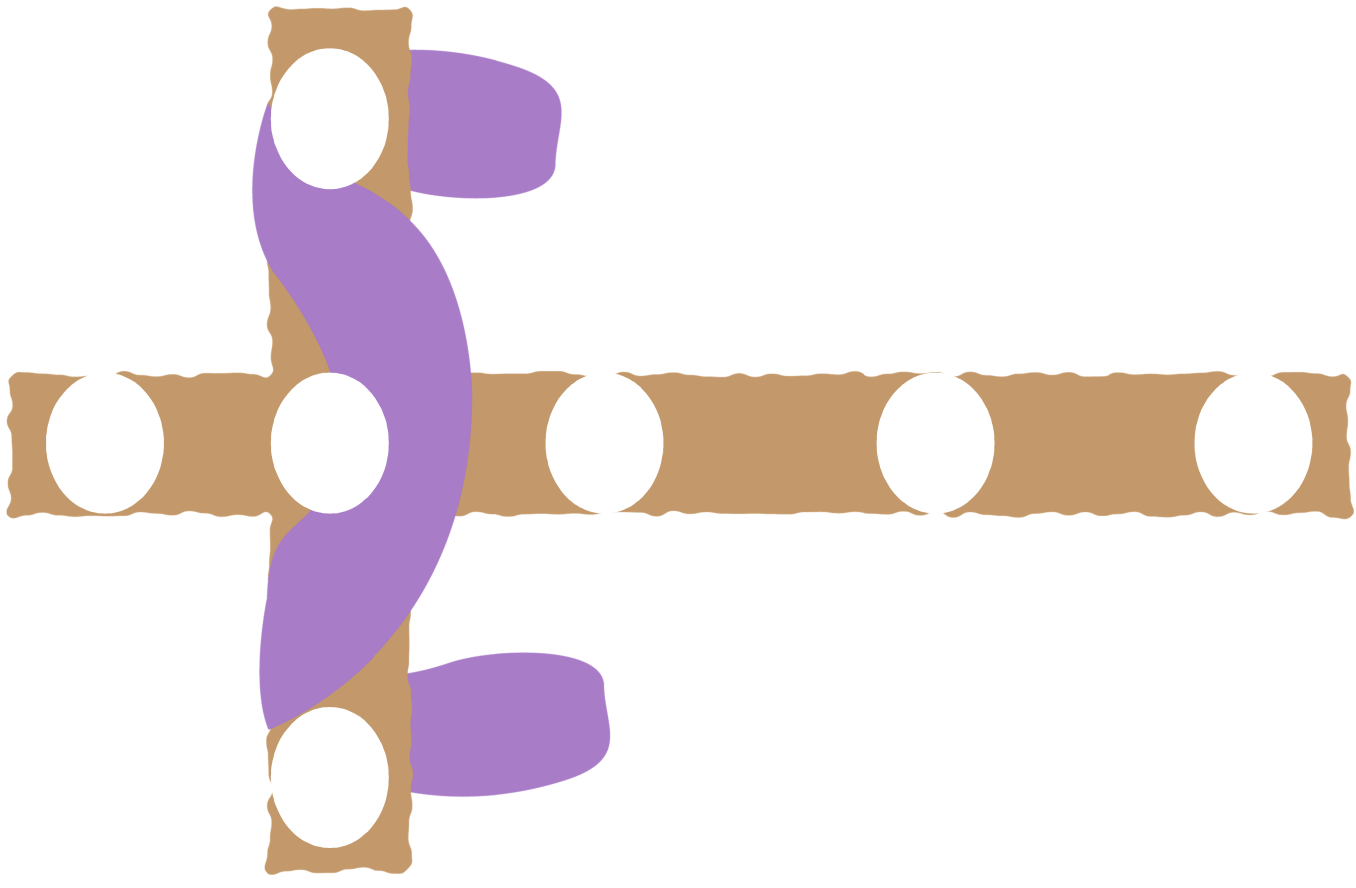
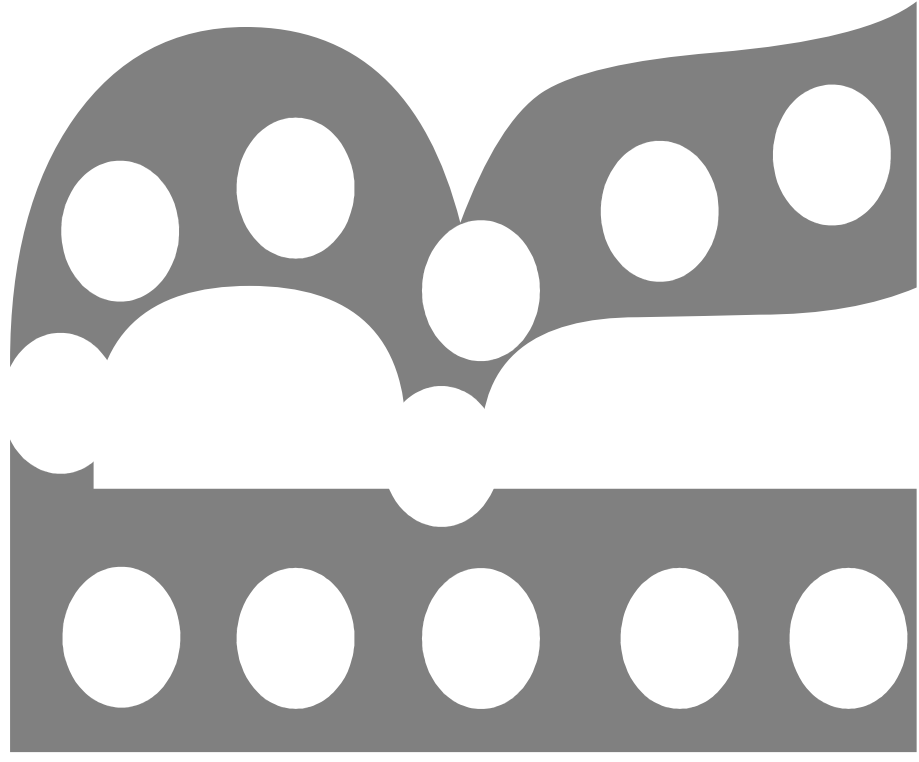

**is for risen.**

E

is for Easter



E E E

e e e

Easter Easter Easter

J

is for Jesus



J J J

j j j

Jesus Jesus Jesus

R

is for risen



R R R

r r r

risen risen risen

T

is for tomb

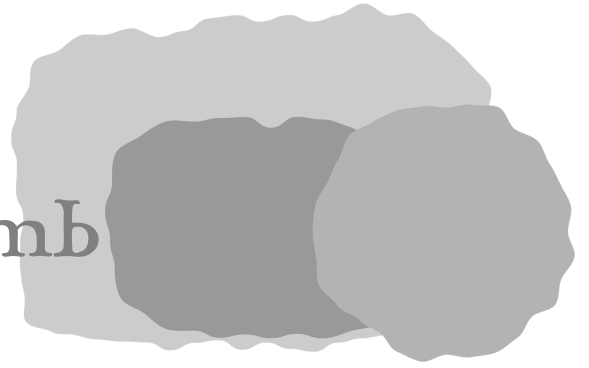

T T T

t t t

tomb tomb tomb

# Easter Writing Project



**Directions:** Complete the writing prompt page on the following page. Then cut, and fold, then paste the image of Jesus on to the top of the writing prompt page. Glue the writing prompt page onto a piece of spring colored construction paper. Then proudly hang it on your wall to help celebrate Easter!



For my family Easter means ...

Handwriting practice area consisting of 10 sets of horizontal lines. Each set includes a solid top line, a dashed midline, and a solid bottom line.

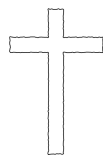

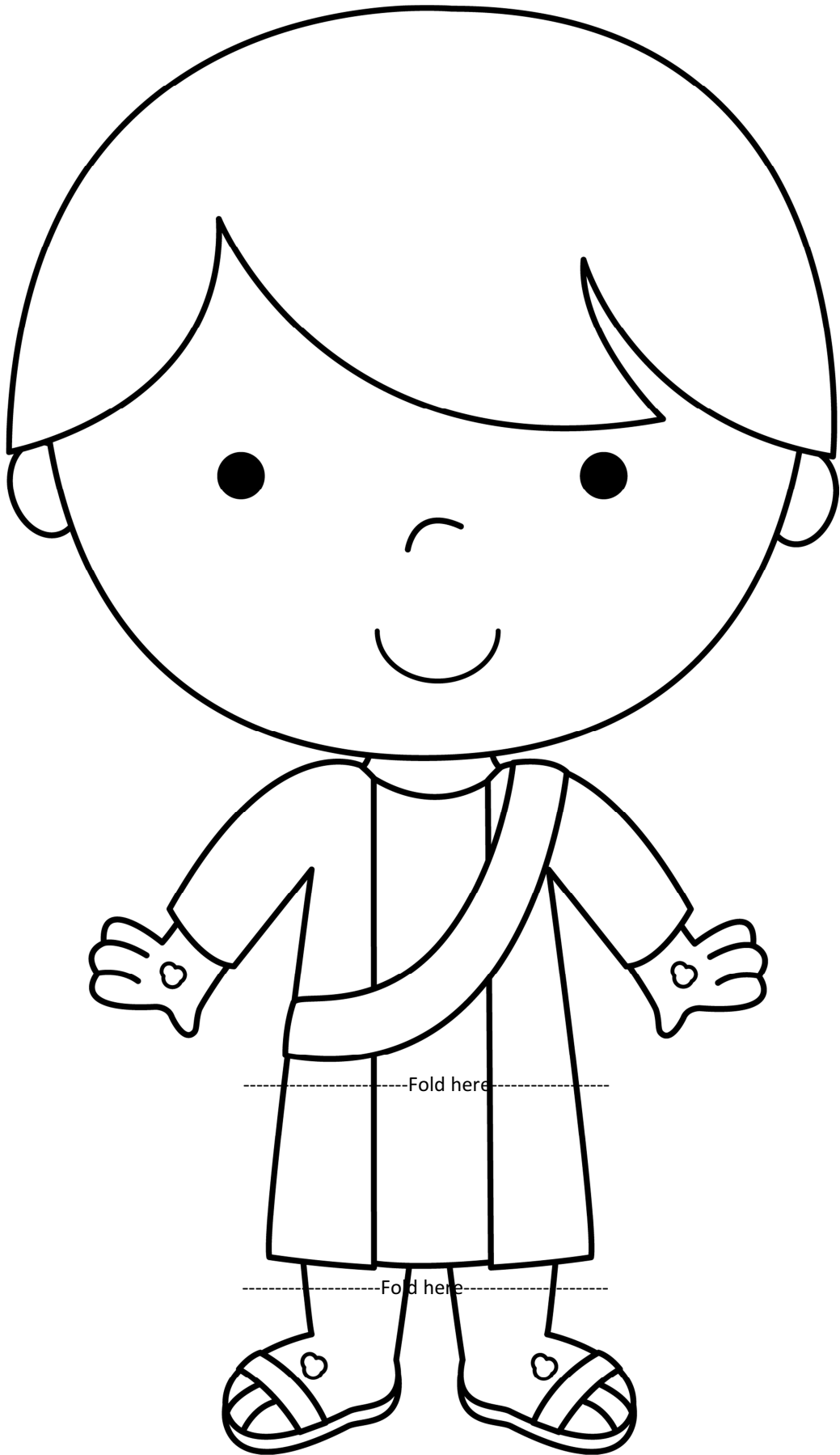

# Smallest to Largest

**Directions:** Circle the smallest picture with a green crayon. Circle the largest picture with a purple crayon.

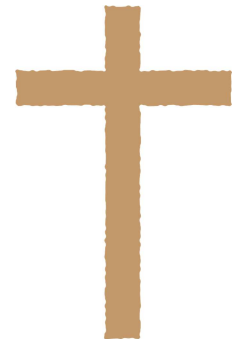
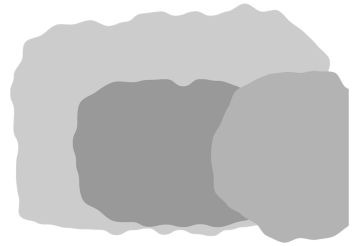
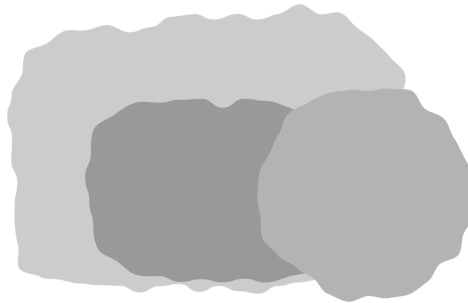

# Perform a Puppet Show

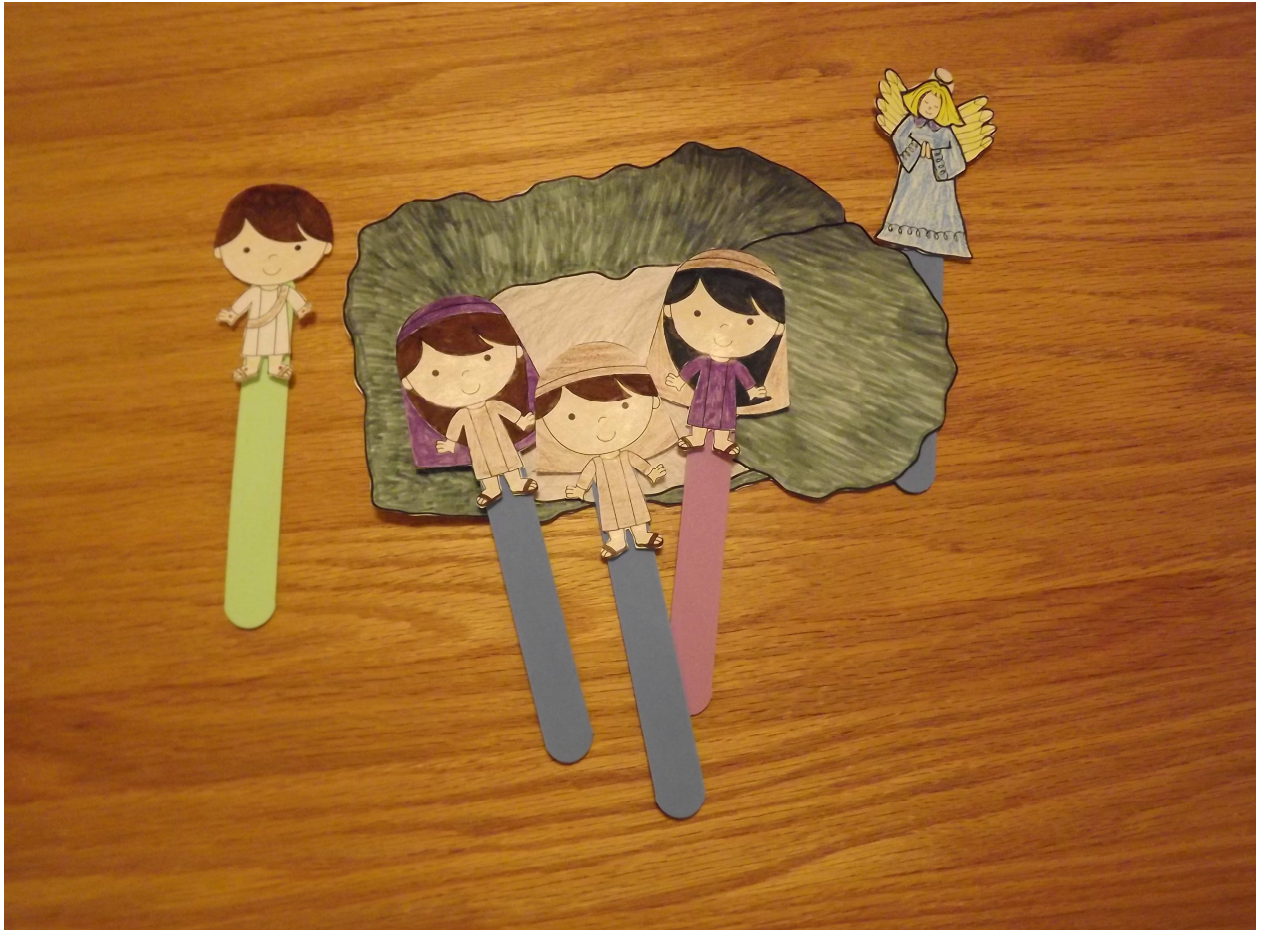

**Directions:** Cut out the puppets of Jesus, the Disciples and the tomb. Glue the puppets onto something rigid like straws or popsicle sticks to use with your puppet show. Then, act out and read the excerpt from John:20 to tell the story of Mary Magdalene and Jesus rising again.

## King James Version from John:20

1 The first day of the week cometh Mary Magdalene early, when it was yet dark, unto the sepulchre, and seeth the stone taken away from the sepulchre.

2 Then she runneth, and cometh to Simon Peter, and to the other disciple, whom Jesus loved, and saith unto them, They have taken away the LORD out of the sepulchre, and we know not where they have laid him.

3 Peter therefore went forth, and that other disciple, and came to the sepulchre.

4 So they ran both together: and the other disciple did outrun Peter, and came first to the sepulchre.

5 And he stooping down, and looking in, saw the linen clothes lying; yet went he not in.

6 Then cometh Simon Peter following him, and went into the sepulchre, and seeth the linen clothes lie,

7 And the napkin, that was about his head, not lying with the linen clothes, but wrapped together in a place by itself.

8 Then went in also that other disciple, which came first to the sepulchre, and he saw, and believed.

9 For as yet they knew not the scripture, that he must rise again from the dead.

10 Then the disciples went away again unto their own home.

11 But Mary stood without at the sepulchre weeping: and as she wept, she stooped down, and looked into the sepulchre,

12 And seeth two angels in white sitting, the one at the head, and the other at the feet, where the body of Jesus had lain.

13 And they say unto her, Woman, why weepest thou? She saith unto them, Because they have taken away my LORD, and I know not where they have laid him.

14 And when she had thus said, she turned herself back, and saw Jesus standing, and knew not that it was Jesus.

15 Jesus saith unto her, Woman, why weepest thou? whom seekest thou? She, supposing him to be the gardener, saith unto him, Sir, if thou have borne him hence, tell me where thou hast laid him, and I will take him away.

16 Jesus saith unto her, Mary. She turned herself, and saith unto him, Rabboni; which is to say, Master.

17 Jesus saith unto her, Touch me not; for I am not yet ascended to my Father: but go to my brethren, and say unto them, I ascend unto my Father, and your Father; and to my God, and your God.

18 Mary Magdalene came and told the disciples that she had seen the LORD, and that he had spoken these things unto her.

19 Then the same day at evening, being the first day of the week, when the doors were shut where the disciples were assembled for fear of the Jews, came Jesus and stood in the midst, and saith unto them, Peace be unto you.



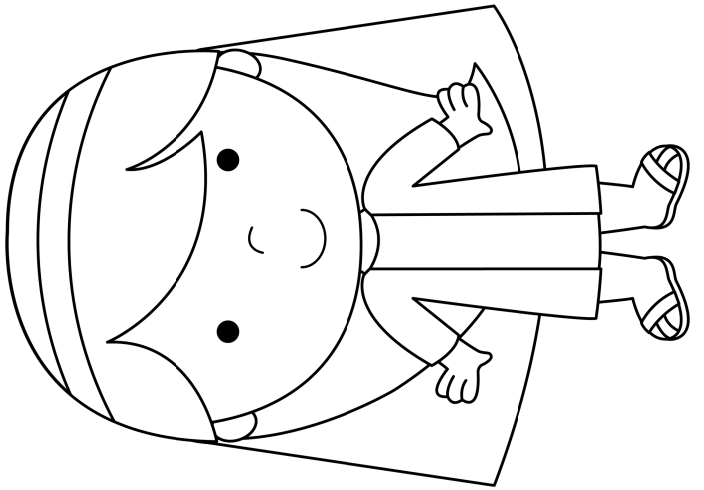
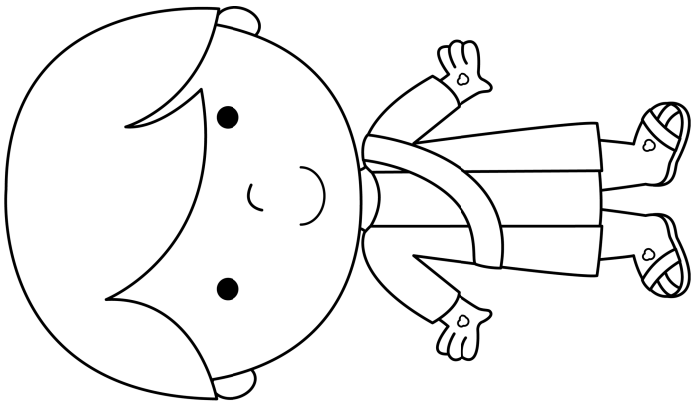
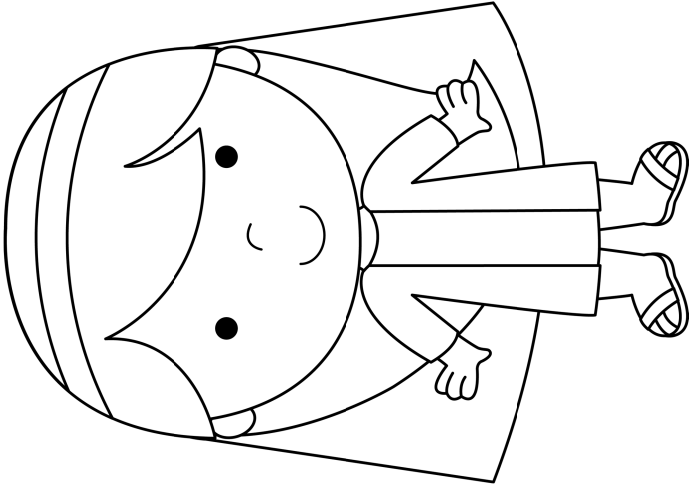
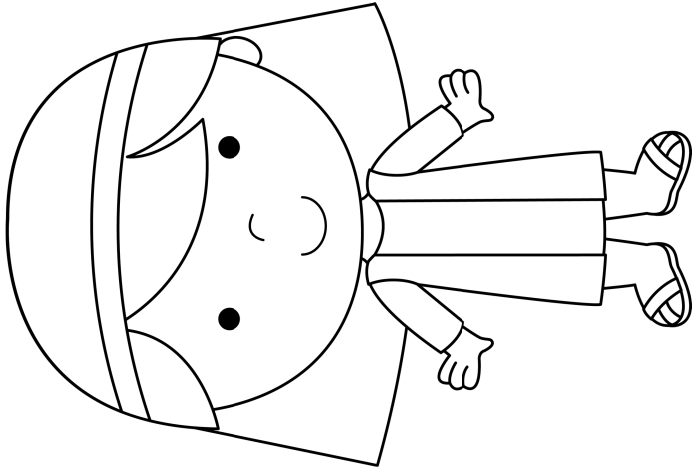
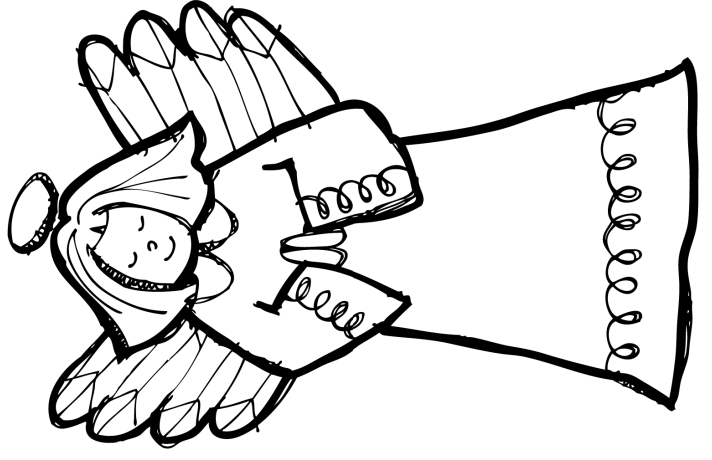

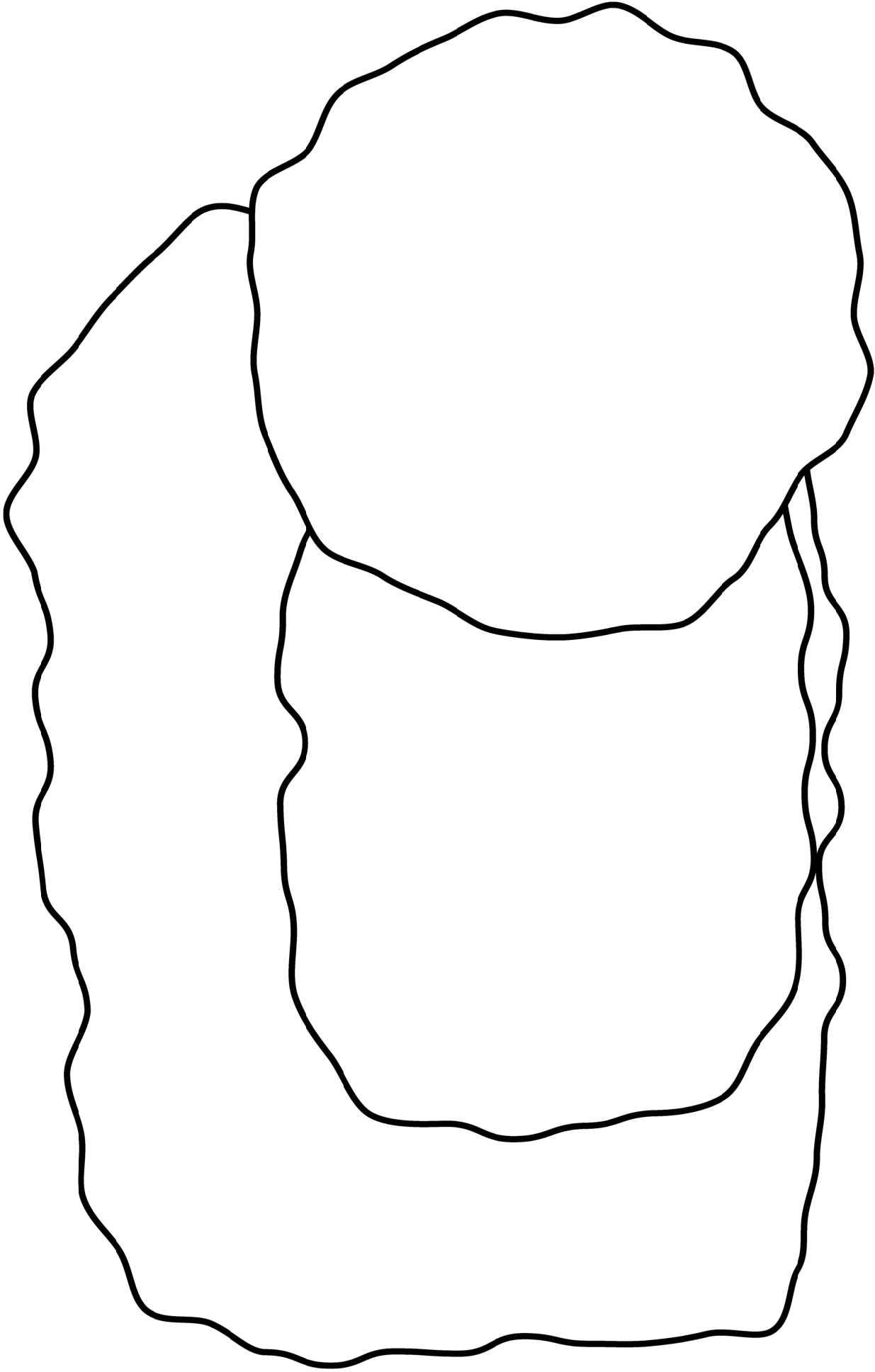



**Directions:** Cut out the image below into strips on the dotted lines. Then have your child practice number order by completing the picture.

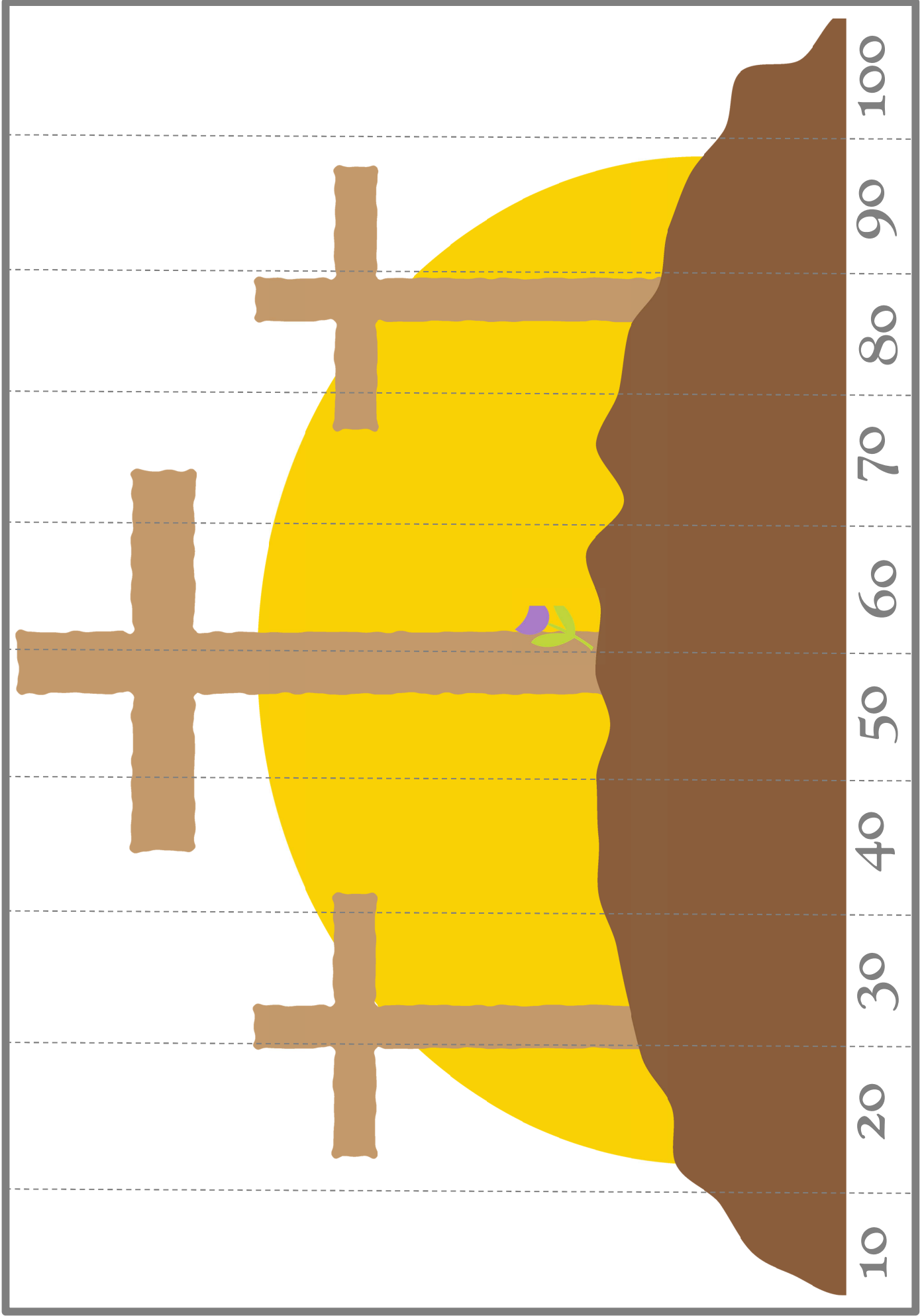

# Color by Double Digit Addition

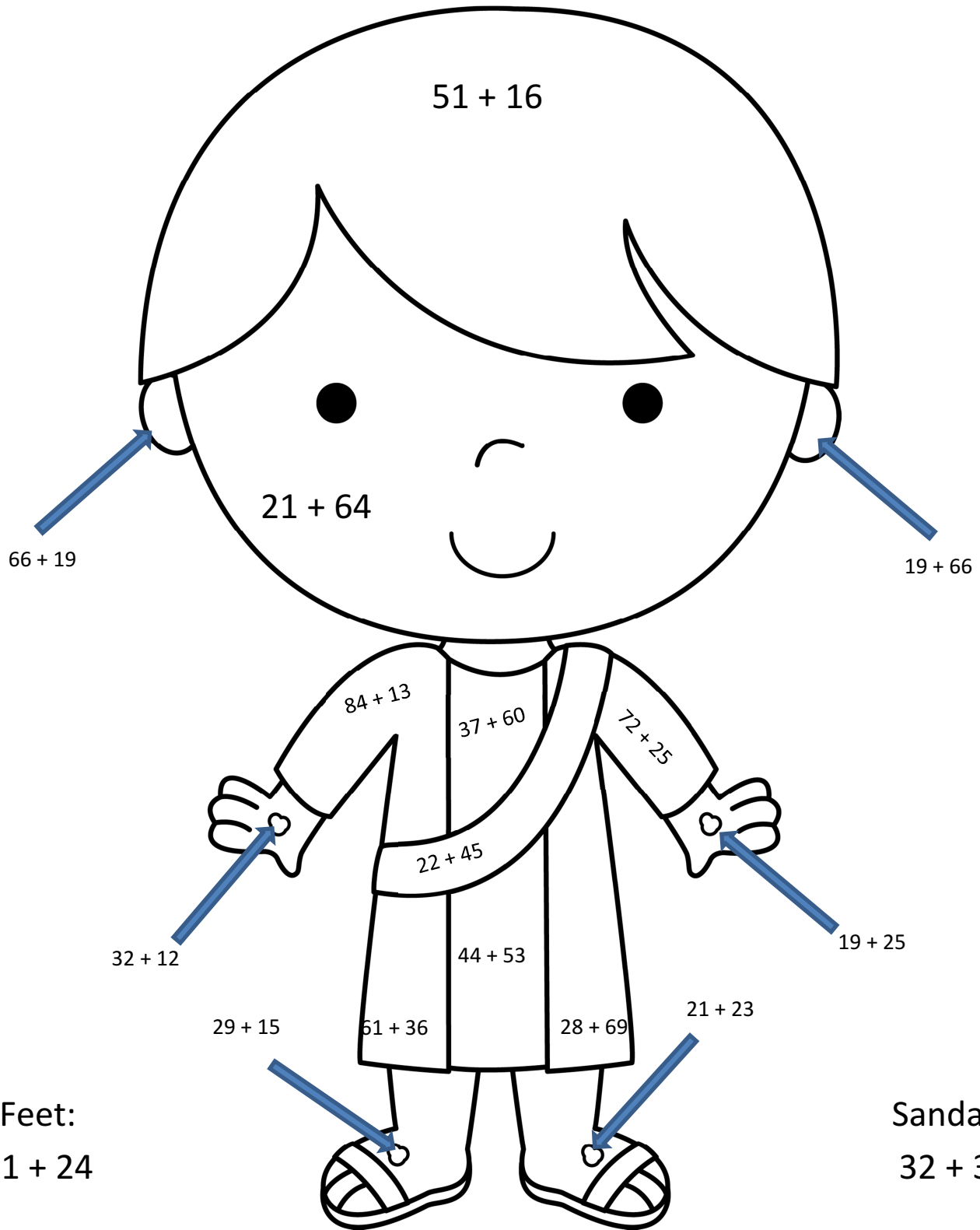

Brown = 67   Peach = 85   Red = 44   White = 97

# Color by Double Digit Subtraction

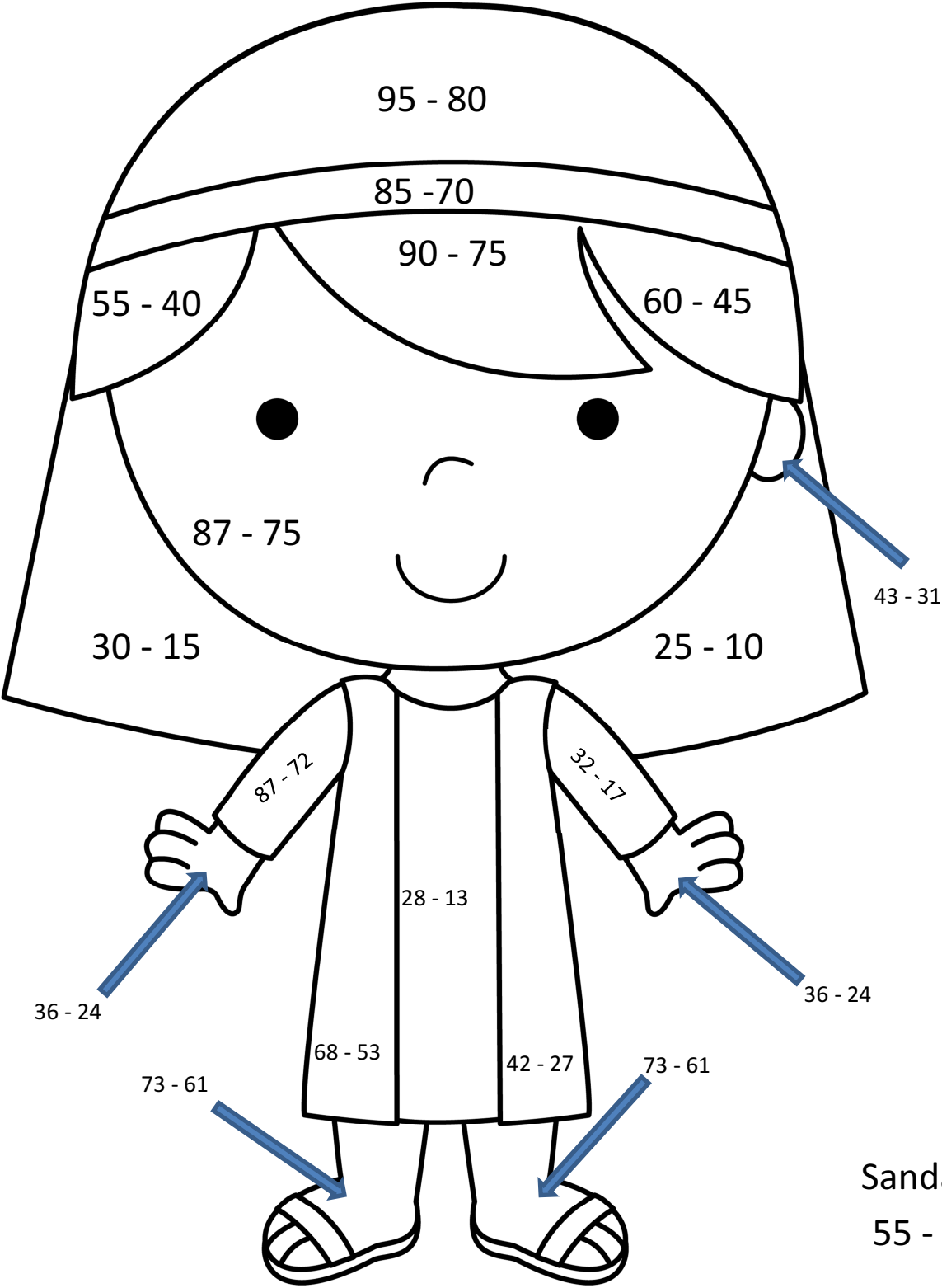

Sandals:  
55 - 40

Peach = 12      Brown = 15

# Color by Addition

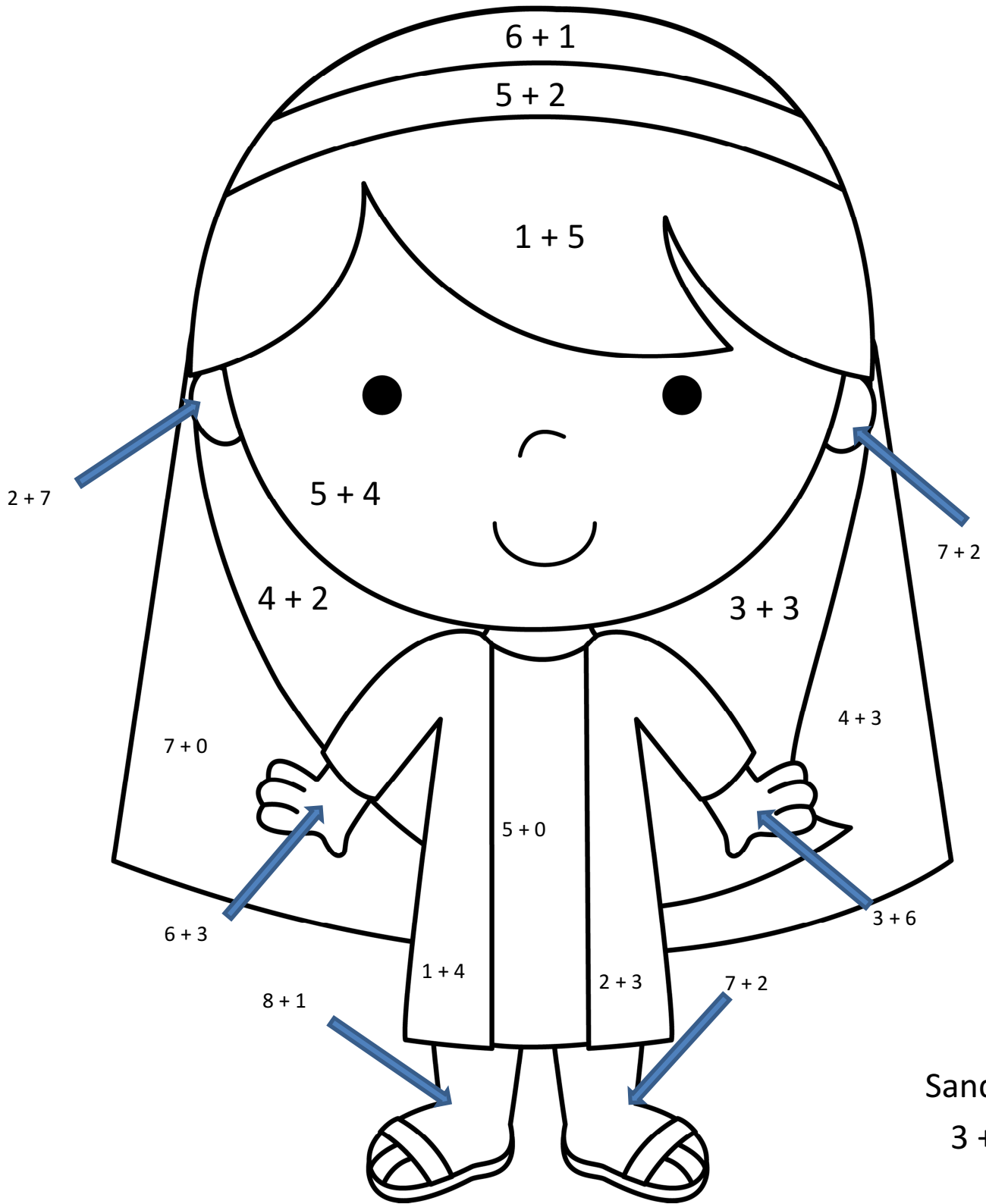

Peach = 9

Brown = 5

Purple = 7

Black = 6

# Color by Subtraction

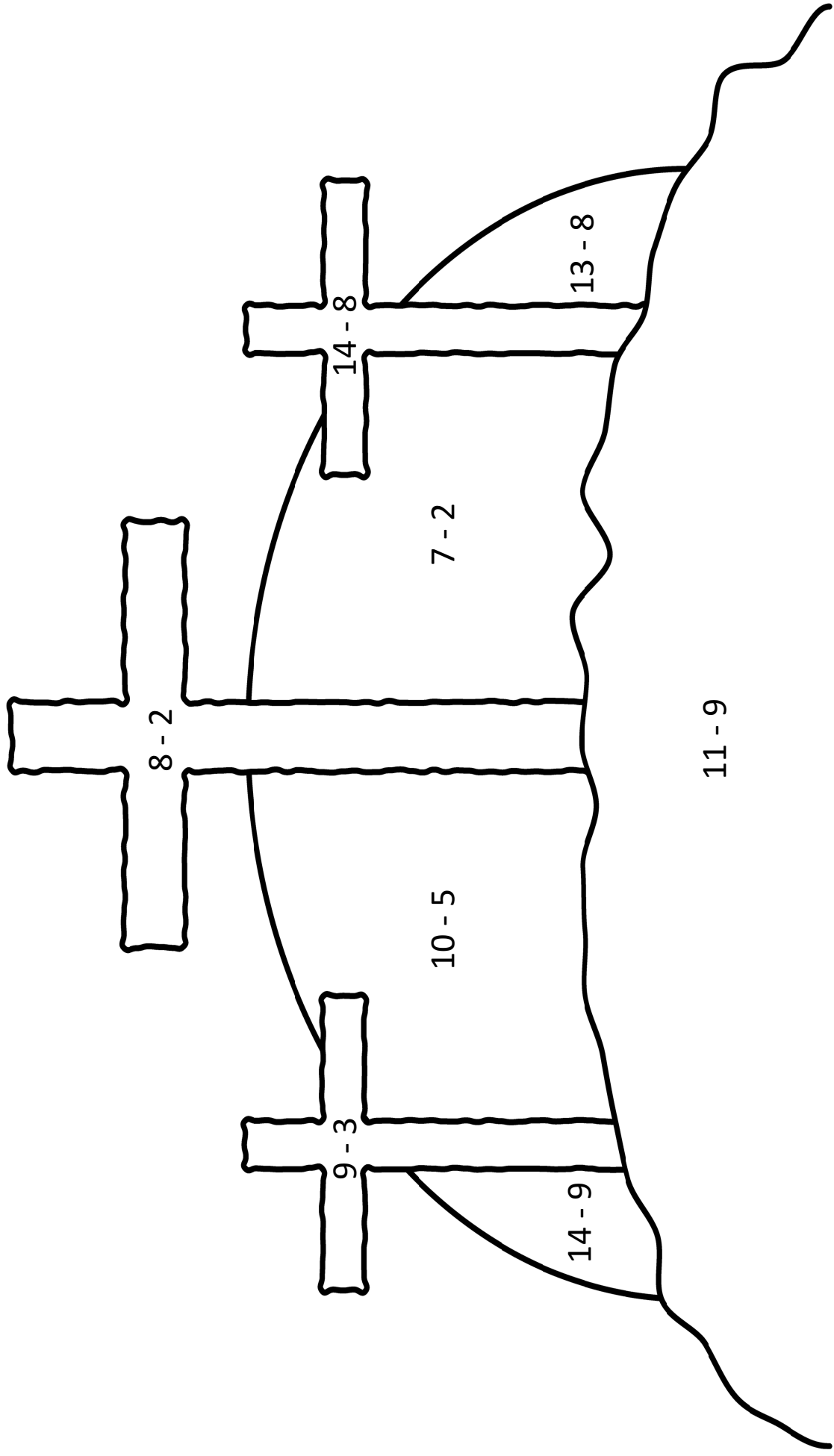

Brown = 6    Tan = 2    Yellow = 5

# Color by Multiplication

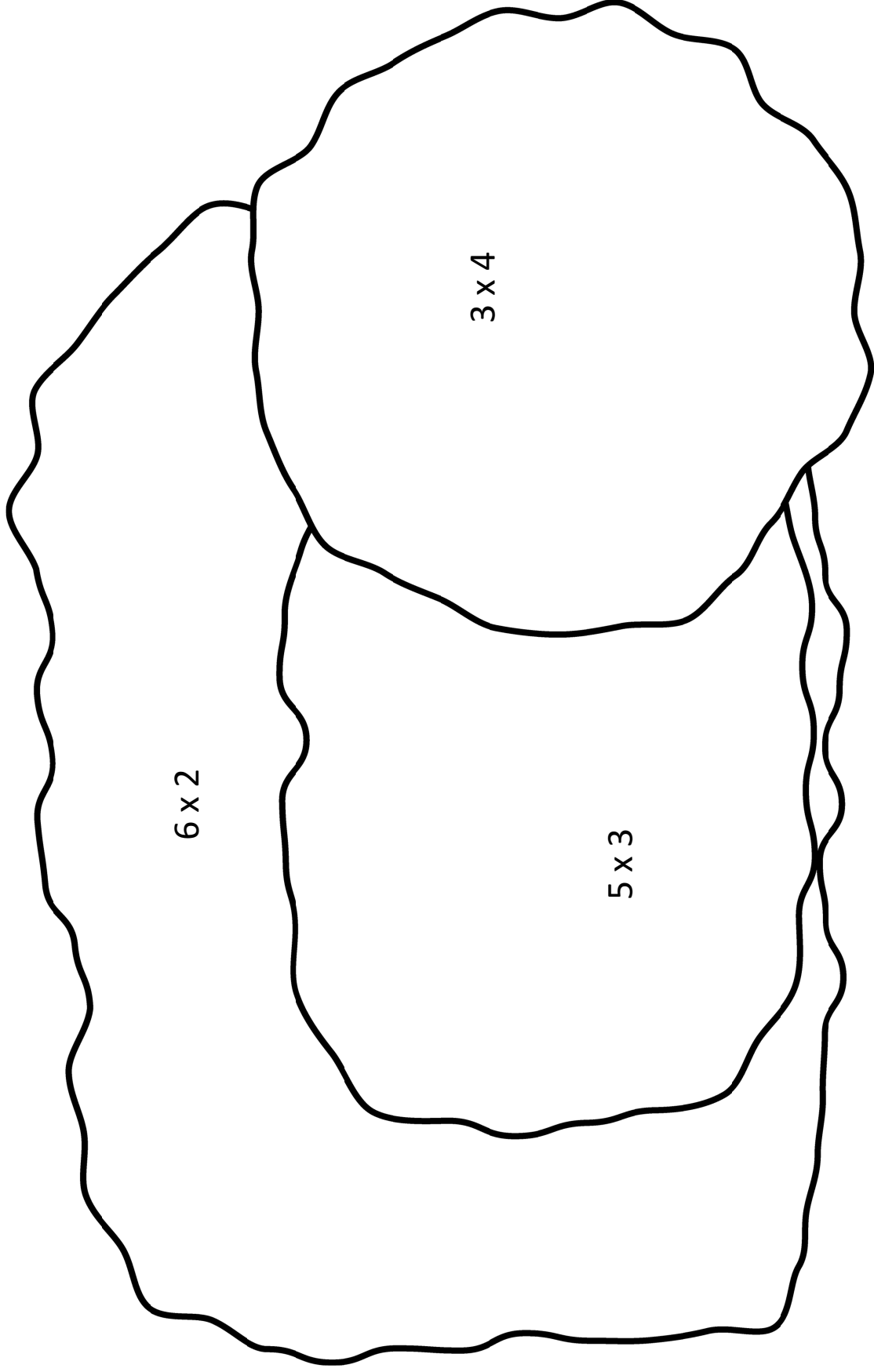

**Black = 15**      **Gray = 12**

# Color by Least and Greatest

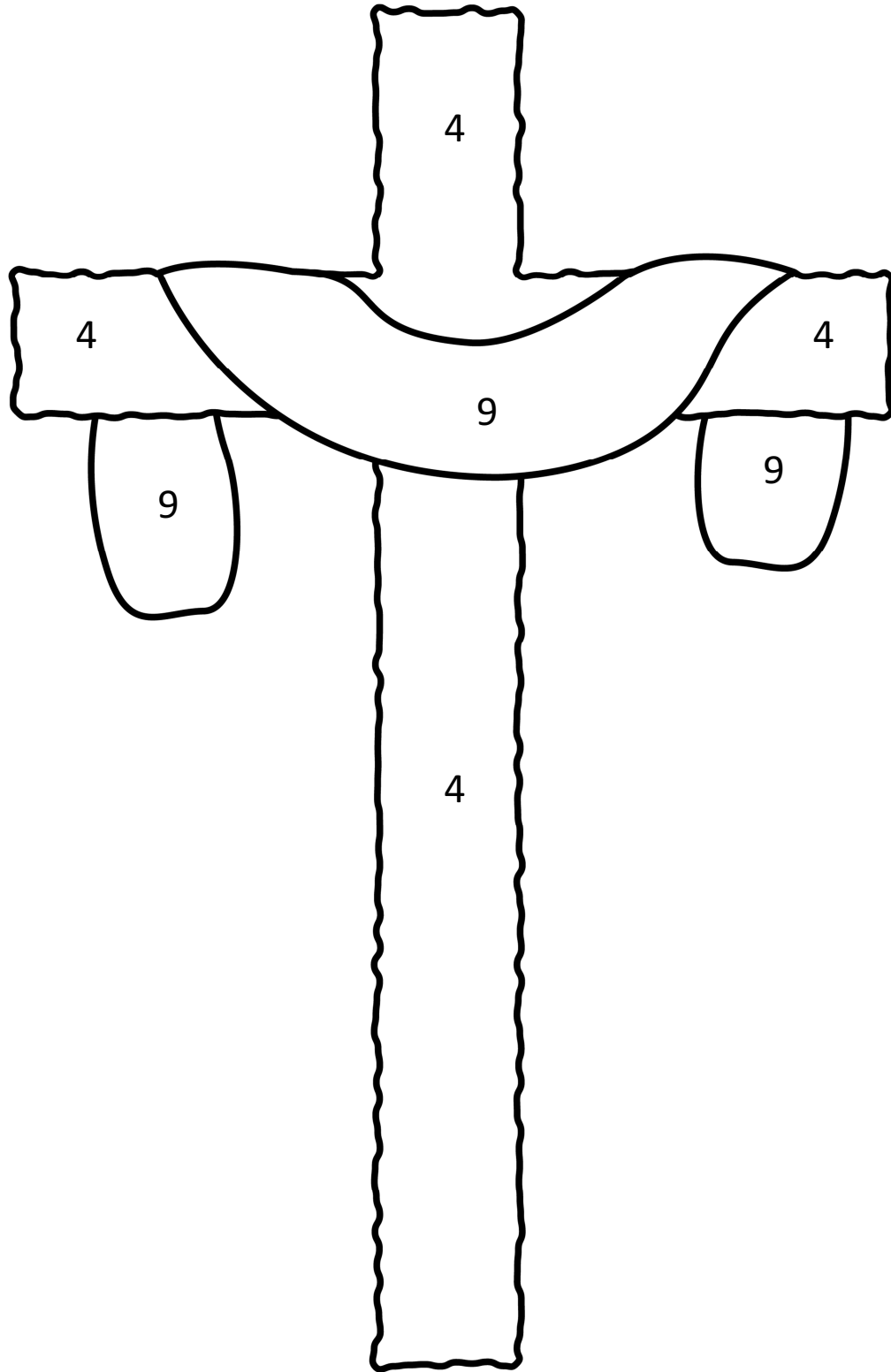

Purple = Greatest Number

Brown = Least Number